

FALCON FX400

360 X 1W CW / 384 X 0.5W RGB
IP65 Strobe

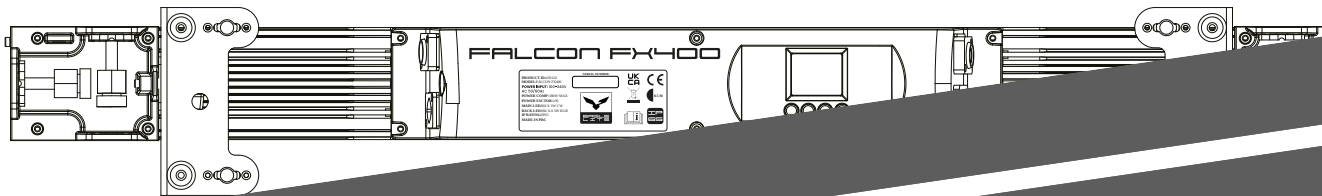

WWW.EAGLELITE.EU

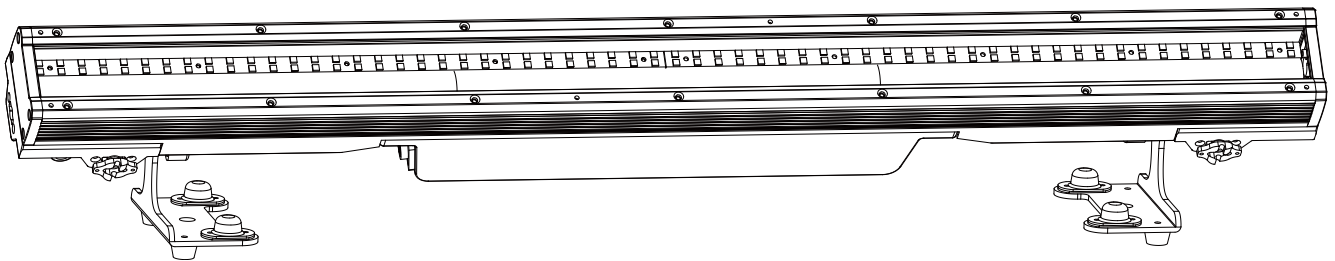

INFO@EAGLELITE.DK





Content

Info about the product	3
Product Features	3
General information before use	4
Safety instructions	5
Uses	5
Danger from electricity	6
Instructions for using the device	6
Service and maintenance of the device	7
Cleaning and maintenance	7
Unpacking/Setup	8
Rigging	9
DMX Guide	9
RDM (Remote Device Management)	11
Power setup	13
Accessory	14
Description of the device	15
Backpanel	15
Front	16
Size measured in mm	17
Lux Measurements	18
Display	18
Menu overview	19
Software update guide	23
Specifications	24
Led Partition maps	25
DMX CHART	27
5CH Mode	27
12CH Mode	27
24CH Mode	28
38CH Mode	29
52CH Mode	31



FALCON FX400
360 X 1W CW / 384 X 0.5W RGB
NR: 450120
LED STROBE BAR

94CH Mode.....	35
AUTO LIST	40
Shutter List	41
Device Settings (Hold 3s).....	41
Color Macro List	42
CTO Macro List	44
Company info	46



FALCON FX400
360 X 1W CW / 384 X 0.5W RGB
NR: 450120
LED STROBE BAR

Info about the product

Thank you for choosing the Eagle Lite Falcon FX400. This manual is designed to provide you with all the necessary information to understand, set up, and operate your new High-Power IP65 LED Strobe Bar safely and effectively. The Falcon FX400 is a robust and versatile lighting fixture, engineered for professional applications requiring dynamic strobe, blinder, and wash effects.

Product Features

The Eagle Lite Falcon FX400 is a professional-grade LED strobe bar packed with features for outstanding performance and reliability:

- **Powerful Light Source:** Equipped with 360 high-intensity White LEDs and 384 vibrant RGB 5050 1W LEDs.
- **Wide Beam Angle:** Delivers extensive 90° coverage, ideal for broad washes and impactful effects.
- **Versatile Operating Modes:** Offers DMX-512, Master/Slave, and Auto Run modes to suit various control requirements.
- **Flexible DMX Control:** Multiple DMX channel modes available: 3, 10, 22, 36, 50 & 92 Channels for precise control.
- **Dynamic Effects:** Features built-in color mixing, variable color chasing, powerful strobing, and smooth fading capabilities.
- **Smooth Dimming:** Includes 4 selectable dimmer curves for seamless intensity adjustments.
- **Efficient Cooling:** controlled fan for optimal thermal management and quiet operation.
- **User-Friendly Interface:** A clear TFT display combined with four intuitive control buttons allows for easy menu navigation and setup.
- **Durable Construction:** Housed in a rugged aluminium body designed for touring and demanding environments.
- **IP65 Rated:** Fully protected against dust ingress and low-pressure water jets from any direction, making it suitable for outdoor use.
- **RDM Capable:** Supports RDM (Remote Device Management) for convenient remote addressing, configuration, and status monitoring.



FALCON FX400
360 X 1W CW / 384 X 0.5W RGB
NR: 450120
LED STROBE BAR

General information before use



Accountability and attention are requested when using the device.

With high-voltage electricity, there is a danger of shock when touching exposed wires.



Risk of eye damage

Never look directly into the light source. Always wear protection if it is necessary to look directly into the light source.



Always check that you are using the product correctly!

Correct voltage in relation to the specifications specified on the device or manual. Be sure that the device is always grounded. Never open the unit until power is taken off! Check periodically that the cord is not pinched or damaged of any kind. Always check the device and cord time to time. When replacing a fuse, it must be replaced with the same type and rating.



For your own safety and understanding of the device, we strongly recommend that the manual be read through before using the product. Always read warnings and recommendations before use.



Warning: Hot surface

This symbol indicates that the device may become hot in certain places on the device. The device may become hot during use. Therefore, it is recommended to let the device cool for at least 10 minutes after use. In this way, injury is avoided and best cared for on the device.



Should only be operated by qualified persons.

We strongly recommend that all persons who will be using the device do the following, read the manual before using the device, are qualified to use the device, and can rig equipment properly.



FALCON FX400
360 X 1W CW / 384 X 0.5W RGB
NR: 450120
LED STROBE BAR

Safety instructions

Uses

- The Falcon FX400 is an LED lighting fixture designed for creating decorative and dynamic lighting effects in professional event technology, such as on stages, in clubs, for architectural illumination, and at festivals.
- It is not designed or suitable for standard household room illumination.
- Use this device only as described in this manual. Any other use may lead to damage to the unit and void the warranty. Eagle Lite accepts no liability for damages resulting from improper use or failure to comply with these instructions.



FALCON FX400
360 X 1W CW / 384 X 0.5W RGB
NR: 450120
LED STROBE BAR

Danger from electricity

- **IP65 Rating:** While the fixture is IP65 rated for outdoor use, ensure that all power and DMX connections are also IP65 rated and properly sealed to maintain protection against water and dust ingress.
- **Do Not Open:** To reduce the risk of electric shock, do not open any part of the fixture's housing unless explicitly instructed for maintenance by qualified personnel and with the unit disconnected from power.
- **Proper Outlet & RCD:** Connect the device only to a properly installed mains socket outlet protected by a Residual Current Device (RCD) or Ground Fault Circuit Interrupter (GFCI).
- **Grounding:** The fixture must be connected to an earthed (grounded) mains supply. Never disable or bypass the protective earth connection of the power cord or fixture.
- **Wet Hands:** Never touch the power plug or fixture with wet or damp hands.
- **Disconnect Power:** Always disconnect the fixture from the mains power supply during thunderstorms, before cleaning, or when it will not be used for an extended period. Pull by the plug, not the cord.

Instructions for using the device.

- **Operating Temperature:** The specified ambient operating temperature range for the Falcon FX400 is -20°C to $+40^{\circ}\text{C}$ (-4°F to 104°F). Do not operate the device outside this range.
- **Surface Temperature:** The housing of the fixture can reach high temperatures during operation (up to 65°C or more). Avoid direct contact by personnel and keep flammable materials at a safe distance.
- **Ventilation & Clearance:** Ensure a minimum distance of 0.5 meters (20 inches) between the fixture and any flammable materials or illuminated surfaces. Maintain adequate ventilation around the unit; do not cover any ventilation openings.
- **Photosensitive Epilepsy:** Strobe effects can trigger epileptic seizures in photosensitive individuals. Be cautious when using intense strobe effects in public areas.
- **Secure Installation:** Ensure the fixture is installed securely by qualified personnel to prevent it from falling. Comply with all relevant local and national safety standards and regulations for rigging and overhead mounting (e.g., EN 60598-2-17).
- **Secondary Safety Attachment:** When mounting the fixture overhead, it **MUST** be secured with a secondary safety attachment, such as an appropriately rated safety cable, attached to a suitable load-bearing point on the fixture and the support structure. The safety cable must be capable of holding at least 10 times the weight of the fixture.
- **Restricted Area:** Ensure the area below the installation site is clear and restricted during rigging, de-rigging, and servicing operations.
- **Experienced Installers:** Overhead mounting requires extensive experience, including calculating working load limits, knowledge of installation materials, and periodic safety inspections. If you lack these qualifications, do not attempt the installation yourself. Installations should be checked by a skilled person at least once a year.
- **Mounting Positions:** The Falcon FX400 can be operated in any mounting position (horizontal, vertical, or angled) provided it is securely fastened.



FALCON FX400
360 X 1W CW / 384 X 0.5W RGB
NR: 450120
LED STROBE BAR

Service and maintenance of the device.

- The device is not designed for permanent operation; therefore, it is important to the device for consistent operational breaks. This helps to ensure service life without defects.
- Never turn the device on and off at short intervals. This will significantly reduce the service life.
- If the device has been subjected to drastic temperature fluctuations, do not turn it on immediately. The arising condensation can destroy the device. Allow the device to reach ambient temperature before connecting. Wait until condensation has evaporated.
- After use, the unit must always be allowed to cool before it is derigged if this is not complied with, and the unit is subsequently defective. The warranty does not apply.
- Please use the original packaging to protect the device from vibration, dust and moisture during transport or storage.
- If a serial number label is mounted to the device, do not remove the label as this will void the warranty.

Cleaning and maintenance

Regular cleaning and maintenance are essential for ensuring optimal performance and longevity of your Falcon FX400.

- **Disconnect Power:** Always disconnect the fixture from the power supply and allow it to cool completely before performing any cleaning or maintenance.
- **Exterior Cleaning:** Periodically clean the exterior housing and lenses to remove dust, dirt, and other residues. Use a soft, lint-free cloth. For stubborn dirt, the cloth can be slightly dampened with a mild cleaning solution (e.g., glass cleaner for lenses, mild detergent for housing).
- **Avoid Solvents:** Never use aggressive solvents, alcohol, or abrasive cleaners, as they can damage the surfaces or optical components.
- **Dry Thoroughly:** Ensure no moisture enters the fixture. The unit must be completely dry before reconnecting it to the power supply.
- **IP65 Connectors:** Regularly inspect IP65 rated connectors for damage or wear to their seals. Ensure connector caps are used when ports are not in use to maintain IP rating.
- **Internal Maintenance:** There are no user-serviceable parts inside the Falcon FX400 beyond what may be instructed by authorized personnel. Do not open the housing unless qualified. Internal cleaning (e.g., fan cleaning) should only be performed by authorized service technicians.
- **Spare Parts:** If spare parts are needed, use only genuine Eagle Lite original parts or equivalents specified by Eagle Lite.
- **Service:** All service and repair operations should be carried out by authorized Eagle Lite dealers or qualified service technicians.



FALCON FX400
360 X 1W CW / 384 X 0.5W RGB
NR: 450120
LED STROBE BAR

Unpacking/Setup

- Upon receiving your Falcon FX400, carefully unpack it and check for any damage that may have occurred during transportation.
- If the shipping carton appears damaged, inspect the fixture immediately.
- In case of damage, or if parts are missing, contact your dealer or Eagle Lite customer service. Do not operate a damaged fixture.
- It is advisable to keep the original packaging for future transportation or storage. If custom flight cases are used, ensure they provide adequate protection against vibration, dust, and moisture.



Warning of the risk of overheating.

The distance between the Device and the illuminated surface must be more than 1.5 m (19.7 inches).

Prober ventilation is very important.

The temperature around the device should never exceed 45 °C (113 °F).



When using racks, structures etc.

When mounting the device on a tripod, ensure that the stand is in a secure and stable position and that the weight of the device does not exceed the maximum allowable load capacity of the stand.



Possible source of error for data errors

To ensure flawless operation, use dedicated DMX cables and not regular XLR/microphone cables.

Never connect the DMX input or output to audio equipment such as mixers or amplifiers. As this can cause great damage!



Possible damage to the device associated with moisture.

Moisture that can enter open (plugs and couplings) by DMX or power cables can cause short circuits. Therefore, it is very important that the lid is closed if the plug is not being used, and only use IP65 rated connectors Cables etc. Available as an accessory at (www.eaglelite.dk)



FALCON FX400
360 X 1W CW / 384 X 0.5W RGB
NR: 450120
LED STROBE BAR

Rigging

The Falcon FX400 can be mounted in various orientations. Always ensure that any supporting structure (truss, stand, etc.) is capable of safely supporting the weight of the fixture(s) and any dynamic loads.

- **Mounting Brackets:** Use the included Fast Lock (Omega) mounting brackets to attach rigging clamps (not included). The brackets attach to the underside of the fixture. Ensure the fast-lock mechanisms are fully engaged.
- **Clamps:** Use appropriately rated rigging clamps to secure the fixture to trusses or pipes.
- **Overhead Mounting:**
 - When mounting overhead, a secondary safety attachment (e.g., safety cable) is MANDATORY.
 - Attach the safety cable through the designated safety cable attachment points on the fixture's chassis and secure it to a separate, reliable anchoring point on the rigging structure.
 - The safety cable must be rated to hold at least 10 times the weight of the fixture.
 - Ensure there is no slack in the safety cable that would allow the fixture to drop significantly if the primary mounting failed, but allow enough for normal movement if applicable.
- **Orientation:** The fixture can be hung upside-down, mounted sideways, or placed on a stable, flat surface. Ensure stability in all positions.
- **Working Area:** Always secure the working area below when rigging, de-rigging, or servicing the fixture.
- **Regular Inspection:** Periodically inspect all rigging hardware, brackets, clamps, and safety attachments for any signs of wear, fatigue, or damage. Replace any suspect components immediately.

DMX Guide

Explanation of DMX Connections

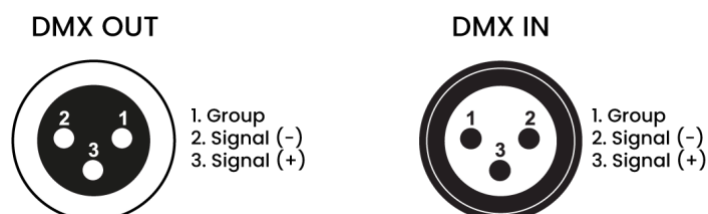

DMX Cable Connectors



FALCON FX400
360 X 1W CW / 384 X 0.5W RGB
NR: 450120
LED STROBE BAR

The fixture is equipped with 3-pin and/or 5-pin XLR connectors for DMX input and output. Cabling must have a male XLR connector on one end and a female XLR connector on the other.

Caution: Do not allow contact between the common (ground/shield) and the fixture's chassis ground if they are separate. Grounding the common can cause a ground loop, and your fixture may perform erratically. Test cables with an ohmmeter to verify correct polarity and to ensure pins are not grounded or shorted to the shield or each other.

DMX Connection & Termination

1. Connect the DMX output of your controller to the DMX IN port of the first Falcon FX400 fixture in the chain.
2. Connect the DMX OUT port of the first fixture to the DMX IN port of the second fixture.
3. Continue daisy-chaining fixtures in this manner (OUT to IN).
4. **DMX Terminator:** On the DMX OUT port of the LAST fixture in the DMX chain, it is highly recommended to install a DMX terminator. A terminator is an XLR connector (male) with a 120 Ohm, 1/4W resistor connected between Pin 2 (DMX-) and Pin 3 (DMX+). Termination reduces signal errors and reflections, especially in long cable runs or noisy environments.



FALCON FX400
360 X 1W CW / 384 X 0.5W RGB
NR: 450120
LED STROBE BAR

RDM (Remote Device Management)

The Falcon FX400 supports RDM, which allows for two-way communication over the DMX line with compatible RDM controllers. RDM enables features such as:

- Remote DMX address setting
- Fixture mode changes
- Sensor monitoring (e.g., temperature)
- Error reporting
- Fixture identification

RDM operates on the same DMX512 cabling. Ensure your DMX controller and any DMX splitters in the line are RDM compatible to utilize these features. RDM packets use non-zero start codes and will not interfere with standard DMX512 devices that do not recognize RDM.

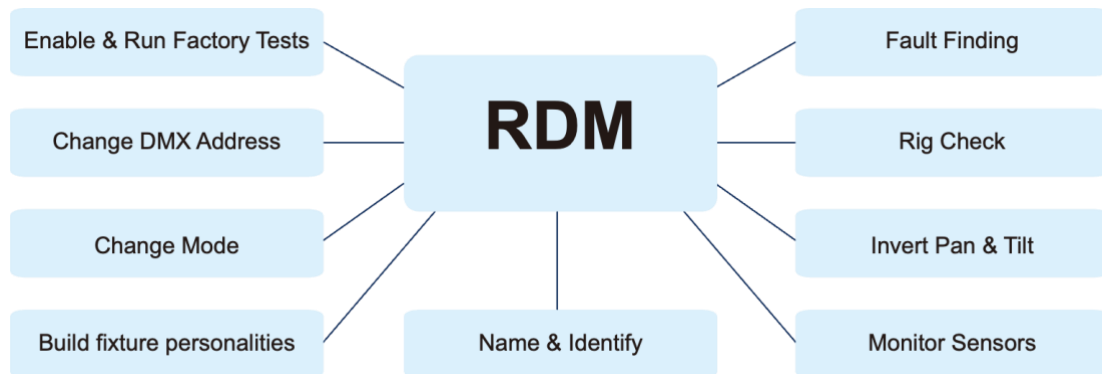



FALCON FX400
360 X 1W CW / 384 X 0.5W RGB
NR: 450120
LED STROBE BAR

RDM INFORMATION

- Manufacturer's ID:0718h
- Manufacturer Label: Eagle Lite
- Model Description: FALCON FX400
- Model ID: f0ed
- Device Label: FX400

Parameter ID	Command "Discovery"	Command "Set"	Command "Get"
DISC_UNIQUE_BRANCH	✓		
DISC_MUTE	✓		
DISC_UN_MUTE	✓		
DEVICE_INFO			✓
SUPPORTED_PARAMETERS			✓
SOFTWARE_VERSION_LABEL			✓
DMX_START_ADDRESS		✓	✓
IDENTIFY_DEVICE		✓	✓
DEVICE_MODEL_DESCRIPTION			✓
PARAMETER_DESCRIPTION			✓
MANUFACTURER_LABEL			✓
DEVICE_LABEL		✓	✓
FACTORY_DEFAULTS		✓	✓
BOOT_SOFTWARE_VERSION_ID			✓
BOOT_SOFTWARE_VERSION_LABEL			✓
DMX_PERSONALITY		✓	✓
DMX_PERSONALITY_DESCRIPTION			✓
SLOT_INFO			✓
SLOT_DESCRIPTION			✓
SENSOR_DEFINITION			✓
SENSOR_VALUE			✓
DEVICE_HOURS			✓
LAMP_HOURS			✓
RESET_DEVICE		✓	
CURVE		✓	✓
DMX_STATE		✓	✓
DIMMER_SPEED		✓	✓



FALCON FX400
360 X 1W CW / 384 X 0.5W RGB
NR: 450120
LED STROBE BAR

Power setup

Correct Connection

- The Falcon FX400 operates on an auto-ranging power supply of AC 110-240V, 50/60Hz.
- Always use the supplied IP65 rated power cable or an equivalent cable with the correct rating.
- Ensure the power source can handle the total current draw of all connected fixtures.
- Standard international wire color coding (ensure consistency with your region if different):
 - Brown: Live (L)
 - Blue: Neutral (N)
 - Yellow/Green: Earth/Ground (PE)

Power Linking

The Falcon FX400 features Power-OUT (IP65 PowerCON compatible) connectors, allowing multiple units to be linked together from a single power source.

- **Power Consumption:** The Falcon FX400 has a maximum power consumption of 300W.
- **Maximum Linked Units:** The number of units that can be safely linked depends on the mains voltage and the capacity of the circuit breaker supplying the power. Always consult local electrical codes and ensure the total load does not exceed 80% of the circuit breaker's rating.

As a general guideline (always verify with local regulations and breaker specifications):

Voltage:	Number of units
110-120V	4
208V	8
230-240V	9

Warning: Do not exceed the maximum number of linked units. Overloading the circuit can cause breakers to trip or create a fire hazard. *Calculations updated for clarity.*

Cable color	Connection explanation	International characters
Brown	Plus	L
Blue	Minus	N
Yellow/Green	Earth	



FALCON FX400
360 X 1W CW / 384 X 0.5W RGB
NR: 450120
LED STROBE BAR

Accessory

Included Accessories

- 1 x Power Cable True1
- 2 x Omega 1/4 Turn Clamps
- 1 x User Manual

Optional Accessories

The following accessories may be available for purchase separately to enhance the functionality of your Falcon FX400:

- Barndoors
- Diffusion Filters
- Custom-length IP65 PowerCON and DMX cables
- Heavy-duty rigging clamps
- Flight Cases (e.g., 2in1, 4in1, 6in1) (Made in EU)

Please contact your Eagle Lite dealer for information on available accessories.



FALCON FX400
360 X 1W CW / 384 X 0.5W RGB
NR: 450120
LED STROBE BAR

Description of the device

Backpanel

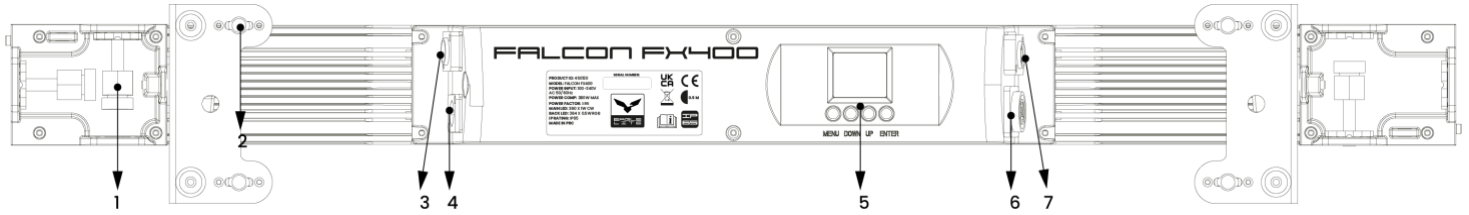

- | | |
|---|---|
| 1 | Splice system |
| 2 | Quarter turn bracket mount |
| 3 | DMX 5-Pin In |
| 4 | True1 Power In |
| 5 | Control panel, with buttons [MODE], [UP], [DOWN], [ENTER] |
| 6 | True1 Power out |
| 7 | DMX 5-Pin out |



FALCON FX400
360 X 1W CW / 384 X 0.5W RGB
NR: 450120
LED STROBE BAR

Front



8 LED Plates & Electronic frost glass

9 Moveable feets



FALCON FX400
360 X 1W CW / 384 X 0.5W RGB
NR: 450120
LED STROBE BAR

Size measured in mm

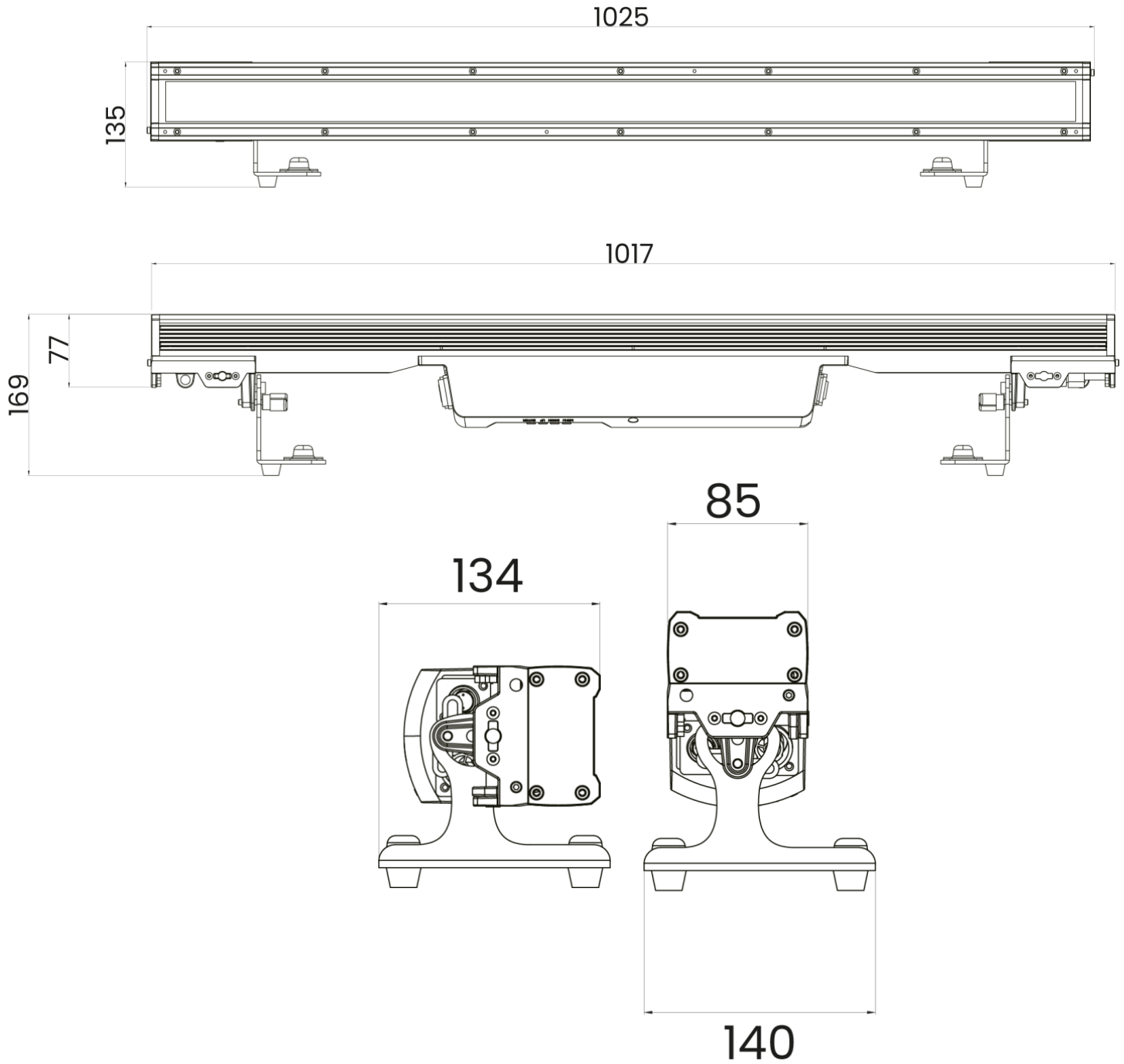



FALCON FX400
360 X 1W CW / 384 X 0.5W RGB
NR: 450120
LED STROBE BAR

Lux Measurements

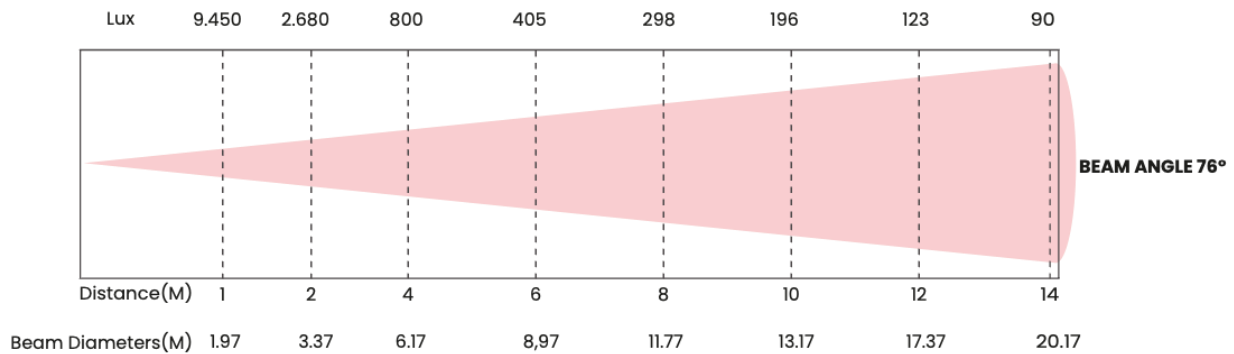

Display

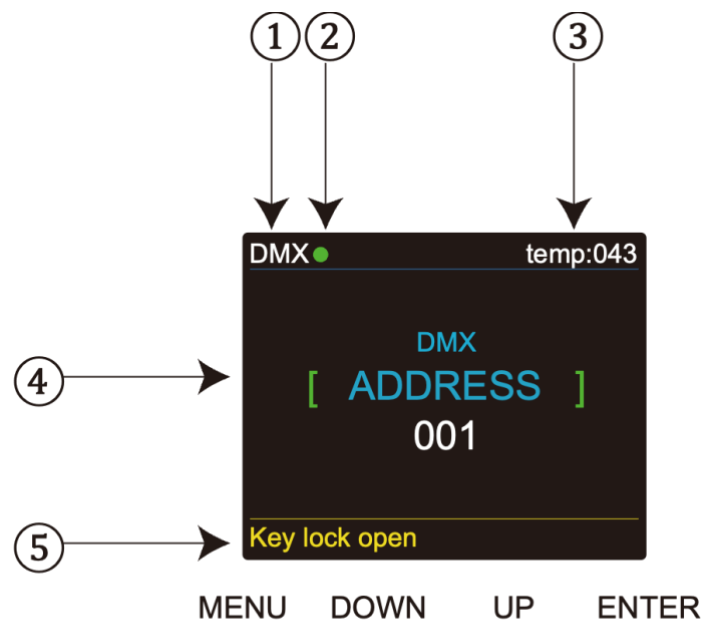

The display provides real-time information and access to the menu system. Key elements typically shown:

1. Mode Indicator: Shows current operating mode (e.g., DMX, SLAVE).
2. Signal Status: A visual indicator (e.g., colored dot) shows DMX signal presence (Green for good signal, Red for interrupted/no signal).
3. Temperature Display: Shows the internal working temperature of the light (e.g., "temp:043"). Color may change (e.g., to yellow) if temperature exceeds a set maximum.
4. Selected Menu/Value: Displays the current menu item or the value being adjusted (e.g., "ADDRESS 001").
5. Key Lock Status: Indicates if the control panel keys are locked or unlocked (e.g., "Key lock open").



Menu overview

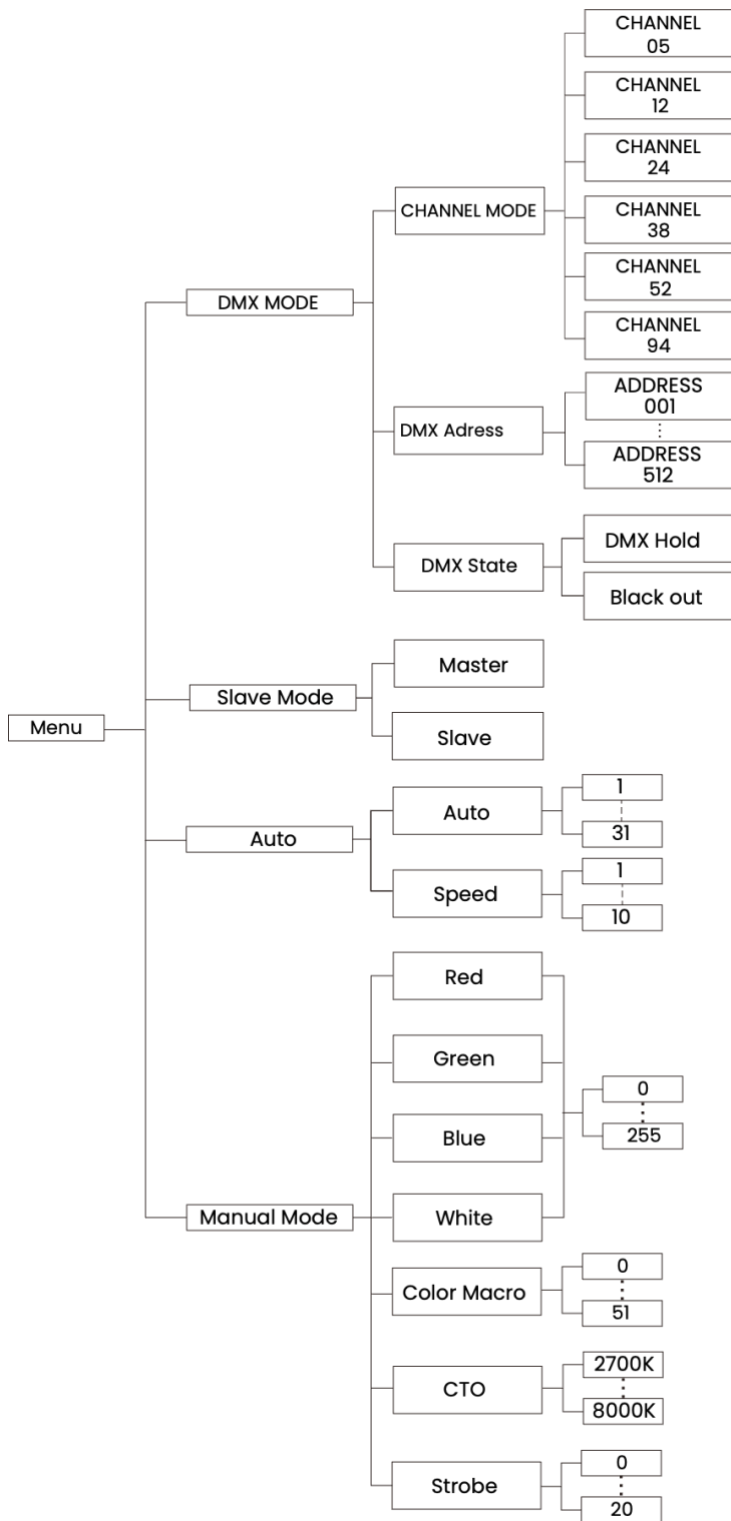

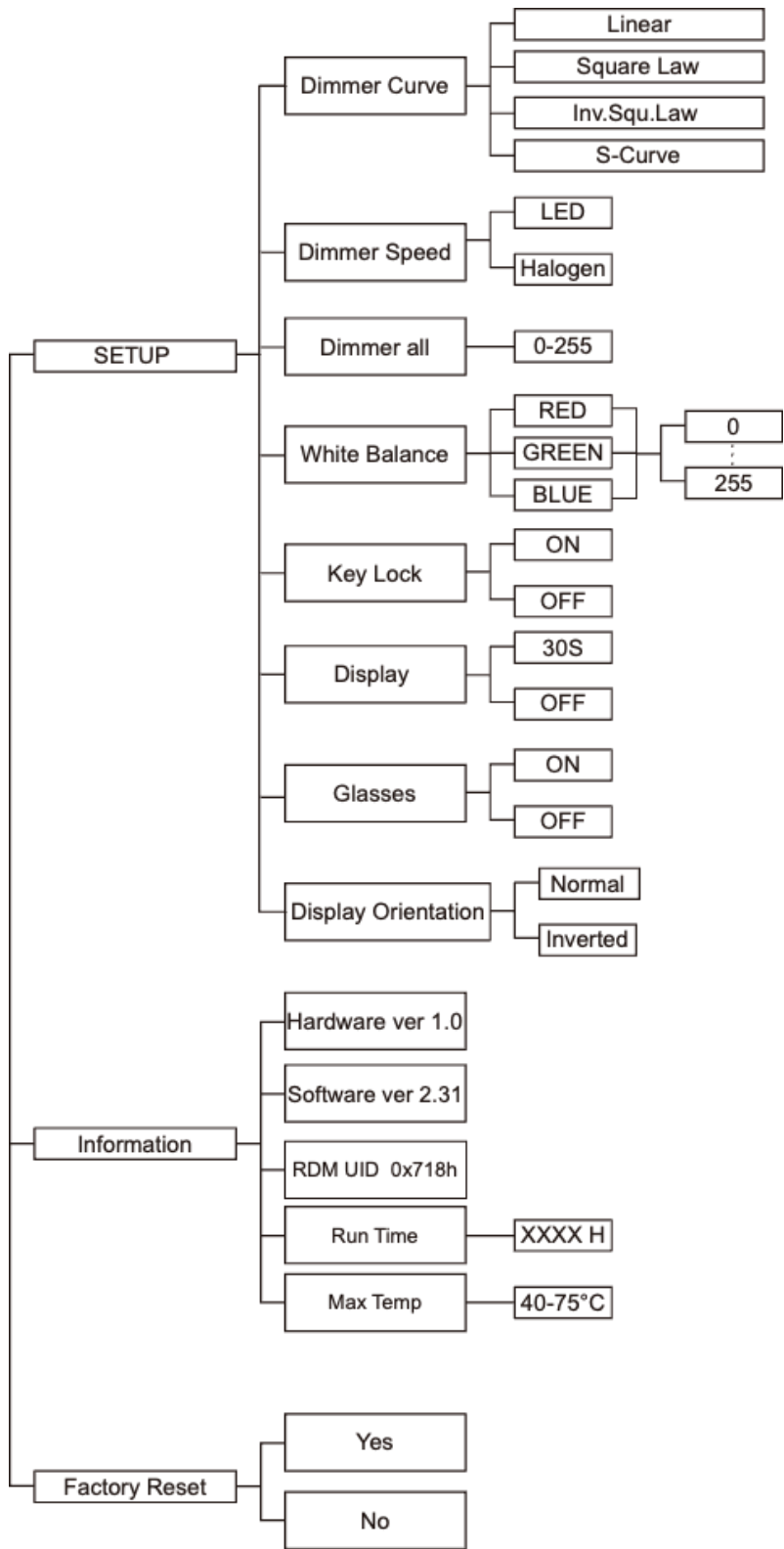



FALCON FX400
360 X 1W CW / 384 X 0.5W RGB
NR: 450120
LED STROBE BAR

DMX MODE

Connects the fixture to a DMX controller.

- **Access:** Press **ENTER**, use UP/DOWN to find "DMX MODE", press **ENTER**.
- **Sub-Menus:**
 - **Address:** (Displayed as "XXX", e.g., 001-512)
 - Use UP/DOWN to select the desired DMX starting address. Press **ENTER** to confirm.
 - **DMX Channel:** (Displayed as "Channel [XX]")
 - Use UP/DOWN to select the DMX channel mode (5CH, 12CH, 24CH, 38CH, 52CH, 94CH). Press **ENTER** to confirm.

DMX STATE

Defines fixture behavior upon DMX signal loss.

- **Access:** Press **ENTER**, use UP/DOWN to find "DMX STATE", press **ENTER**.
- **Options:**
 - **BLACKOUT:** Fixture blacks out if DMX signal is lost.
 - **DMX HOLD:** Fixture holds the last received DMX values if signal is lost.
 - Use UP/DOWN to choose, press **ENTER** to confirm.

SLAVE MODE

Sets the fixture to follow a Master unit.

- **Access:** Press **ENTER**, use UP/DOWN to find "SLAVE Mode", press **ENTER**.
- **Operation:** "SLAVE" will be shown. Press **ENTER** to confirm. The slave unit will now replicate the output of a Master unit (a unit running in Auto Mode or controlled via DMX if configured to output Master signals).

AUTO MODE

Runs built-in automatic programs.

- **Access:** Press **ENTER**, use UP/DOWN to find "AUTO MODE", press **ENTER**.
- **Sub-Menus:**
 - **SPEED:** (Values 01-10, or a wider range like 0-255 if indicated by the DMX chart for auto speed - supplier manual indicates "AUTO 1-AUTO 31" for programs and "01-10" for speed in this menu context)
 - Adjusts the running speed of the auto programs. Use UP/DOWN to select speed (01-10), press **ENTER**.
 - **AUTO MODE (Program Select):** (AUTO 1 - AUTO 31)
 - Selects the desired built-in automatic program. Use UP/DOWN to choose, press **ENTER**.

STATIC COLOR

Manually set static colors and strobe effects.



FALCON FX400
360 X 1W CW / 384 X 0.5W RGB
NR: 450120
LED STROBE BAR

- **Access:** Press **ENTER**, use UP/DOWN to find "STATIC COLOR", press **ENTER**.
- **Sub-Menus:** (Values typically 0-255 for brightness/speed)
 - **RED:** Adjust Red LED brightness (0-255).
 - **GREEN:** Adjust Green LED brightness (0-255).
 - **BLUE:** Adjust Blue LED brightness (0-255).
 - **WHITE:** Adjust White LED brightness (0-255).
 - **COLOR (Macro):** Select from pre-programmed static colors (0-51).
 - **STROBE:** Adjust strobe speed (0-20, representing Hz or steps).
 - Use UP/DOWN for selection/value, press **ENTER** to confirm.

SET UP

Configure various fixture parameters.

- **Access:** Press **ENTER**, use UP/DOWN to find "SET UP", press **ENTER**.
- **Sub-Menus:**
 - **Dimmer Curve:** Select dimming response (Curve 1, Curve 2, Curve 3, Curve 4).
 - **Dimmer Speed:** Select dimming speed/smoothness (LED, Halogen).
 - **Dimmer ALL:** Master dimmer for all LEDs in manual modes (0-255).
 - **White Balance:** Fine-tune RGBW values for custom white points. (Sub-menus for RED, GREEN, BLUE, WHITE adjustment 0-255).
 - **Key Lock:** Enable or disable control panel key lock (ON/OFF).
 - **Display (Backlight):** Set display backlight behavior (ON, OFF after 30s).
 - **Glasses (Frost Effect):** Turn electronic frost filter ON/OFF.
 - **Display Orientation:** Set display to Normal or Inverted.
 - Use UP/DOWN for selection/value, press **ENTER** to confirm.

INFORMATION

View fixture information.

- **Access:** Press **ENTER**, use UP/DOWN to find "INFORMATION", press **ENTER**.
- **Sub-Menus (View only):**
 - **Hardware Ver:** Displays hardware version (e.g., Hardware ver 1.0).
 - **Software Ver:** Displays software version (e.g., Software ver 2.31).
 - **RDM: UID:** Displays the fixture's RDM Unique ID (e.g., RDM UID 0x718h).
 - **Run Time:** Displays total operating hours of the fixture (e.g., XXXX H).
 - **Max Temp (Setting & Display):**
 - Allows setting a maximum desired working temperature (40–75°C).
 - The fixture may automatically adjust performance if this temperature is exceeded.
 - The display might also change color (e.g., to yellow) when the current temperature exceeds this user-set maximum.

FACTORY RESET

Resets all fixture settings to their default values.

- **Access:** Press **ENTER**, use UP/DOWN to find "FACTORY RESET", press **ENTER**.



FALCON FX400
360 X 1W CW / 384 X 0.5W RGB
NR: 450120
LED STROBE BAR

- **Confirmation:** Select "Yes" (or confirm action) to proceed with the reset. Select "No" to cancel.
 - Use UP/DOWN to choose, press **ENTER** to confirm.

Software update guide

The Falcon FX400 firmware can be updated via DMX using our DMX update box/software.

1. Preparation:

- Connect the fixtures in a DMX chain. The first fixture connected to the update box will act as the Master for the update process.
- Set the first fixture to Master mode (if applicable for update or simply ensure it's the first in line). Other fixtures can be in Slave mode or simply powered on in the DMX chain.

2. Connect Update Box:

- Connect the DMX output from the update box to the DMX input of the first (Master) fixture.
- Power on the update box and load the correct firmware file for the Falcon FX400.

3. Initiate Update:

- Follow the instructions provided with the update box/software to start the upload process.
- Typically, the fixture's display will indicate that it is receiving data (e.g., "Loading," progress bar, or color change on display background such as "wait" then "loading" and background color change).

4. Upload Process:

- Do not interrupt power or DMX connections during the update.
- The update may take several minutes. All fixtures in the chain should receive the update.

5. Completion:

- Once the update is successful, the fixture(s) will usually restart automatically with the new firmware. The display should indicate "Upload Success" or similar.
- Verify the new software version in the "INFORMATION" menu.

Always use official Eagle Lite firmware updates and follow the specific instructions provided with the update utility.



FALCON FX400
360 X 1W CW / 384 X 0.5W RGB
NR: 450120
LED STROBE BAR

Specifications

Description	Data
Light Source	Main led: 360 x 1W CW SMD Backlight: 384 x 0.5W RGB SMD
Beam Angle	76° (with frosted glass)
Field Angle	110° (with frosted glass)
Control modes	DMX
	Static, Master Slave, Auto
RDM	Yes, RDM enabled
Dmx Modes	5, 12, 24, 38, 52, 94 channels
Input connector	Power: True1 IP65 / DMX: XLR 5-Pin IP65
Output connector	Power: True1 IP65 / DMX: XLR 5-Pin IP65
Power supply	AC 100 - 240 V 50/60 Hz
Power consumption	380W / 1.65A @ 230v
Power Factor	>0.95
Start-up power	50 A / 375 μ s
Standby power compsumption	11.5W
Protection class	IP65
Mounting options	Hanging, spliced, standing.
Housing Material	Aluminum
Housing Color	Black(RAL-9004)
Size (WxHxD)	1025 x 140 x 192
Weight	9.15 Kg



Led Partition maps

RGB
White
RGB

5/12 CH

5/12 Channel Mode Partition:

- RGB LEDs: Controlled as one single block.
- White LEDs: Controlled as one single block.

RGB 1	RGB 2
White 1	White 2
RGB 4	RGB 3

24 CH

24 Channel Mode Partition:

- RGB LEDs: Divided into 4 controllable sections
- White LEDs: Divided into 2 controllable sections

RGB 1	RGB 2	RGB 3	RGB 4
White 1	White 2	White 3	White 4
RGB 8	RGB 7	RGB 6	RGB 5

38 CH

38 Channel Mode Partition:

- RGB LEDs: Divided into 8 controllable sections
- White LEDs: Divided into 4 controllable sections



FALCON FX400
360 X 1W CW / 384 X 0.5W RGB
NR: 450120
LED STROBE BAR

RGB 1	RGB 2	RGB 3	RGB 4	RGB 5	RGB 6
White 1	White 2	White 3	White 4	White 5	White 6
RGB 12	RGB 11	RGB 10	RGB 9	RGB 8	RGB 7

52 CH

52 Channel Mode Partition:

- RGB LEDs: Divided into 12 controllable sections
- White LEDs: Divided into 6 controllable sections

RGB 1	RGB 2	RGB 3	RGB 4	RGB 5	RGB 6	RGB 7	RGB 8	RGB 9	RGB 10	RGB 11	RGB 12
White 1	White 2	White 3	White 4	White 5	White 6	White 7	White 8	White 9	White 10	White 11	White 12
RGB 24	RGB 23	RGB 22	RGB 21	RGB 20	RGB 19	RGB 18	RGB 17	RGB 16	RGB 15	RGB 14	RGB 13

94 CH

94 Channel Mode Partition:

- RGB LEDs: Divided into 24 controllable sections
- White LEDs: Divided into 12 controllable sections



FALCON FX400
 360 X 1W CW / 384 X 0.5W RGB
 NR: 450120
 LED STROBE BAR

DMX CHART

5CH Mode

5CH Mode	Function	DMX Value	Description
1	Master Dimmer	000-255	0-100% (master Dimmer)
2	(White)Strobe Dimmer	000-255	Sets the overall intensity of the flash effect. Minimum -> Maximum
3	Beam/Strobe Strobe Duration(7-650ms)	000-255	Sets the length of time each flash is visible. 7-650ms
4	Beam/Strobe Strobe Rate(0.299 -> 16.67Hz)	000-255	Sets the frequency of flashes 0.299 -> 16.67Hz
5	Colour Macro	000-215	See colour macro list
	CTO	216-255	See CTO Macro list

12CH Mode

12CH Mode	Function	DMX Value	Description
1	Master Dimmer	000-255	Controls the overall light output intensity (0-100%).
2	(White)Strobe Dimmer	000-255	Sets the overall intensity of the flash effect. Minimum -> Maximum
3	Beam/Strobe Strobe Duration(7-650ms)	000-255	Sets the length of time each flash is visible. 7-650ms
4	Beam/Strobe Strobe Rate(0.299 -> 16.67Hz)	000-255	Sets the frequency of flashes 0.299 -> 16.67Hz
5	No Function	000-003	No Function Open
	Colour Macro	004-195	See colour macro list
	CTO	196-255	See CTO Macro list
6	Shutter	000-255	See Shutter list
7	Frost Glass	000-001	No Function/Open
		002-255	Applies electronic frost effect 0-100%
8	Red Intensity	000-255	Controls the intensity of the Red LEDs (0-100%).
9	Green Intensity	000-255	Controls the intensity of the Green LEDs (0-100%).



FALCON FX400
 360 X 1W CW / 384 X 0.5W RGB
 NR: 450120
 LED STROBE BAR

10	Blue Intensity	000-255	Controls the intensity of the Blue LEDs (0-100%).
11	White Intensity	000-255	Controls the intensity of the White LEDs (0-100%).
12	Device Settings	000-255	Control channel (See device settings)

24CH Mode

24CH Mode	Function	DMX Value	Description
1	Master Dimmer	000-255	Overall light output intensity (0-100%).
2	(White)Strobe Dimmer	000-255	Sets the overall intensity of the flash effect. Minimum -> Maximum
3	Beam/Strobe Strobe Duration(7-650ms)	000-255	Sets the length of time each flash is visible. 7-650ms
4	Beam/Strobe Strobe Rate(0.299 -> 16.67Hz)	000-255	Sets the frequency of flashes 0.299 -> 16.67Hz
5	No Function/Open	000-003	
	Colour Macro	004-195	See colour macro list
	CTO	196-255	See CTO Macro list
6	Shutter	000-255	See Shutter list
7	Frost Glass	000-001	No Function/Open
		002-255	Applies electronic frost effect 0-100%
8	Red Section 1	000-255	Intensity of Red LEDs in Section 1.
9	Green Section 1	000-255	Intensity of Green LEDs in Section 1.
10	Blue Section 1	000-255	Intensity of Blue LEDs in Section 1.
11	Red Section 2	000-255	Intensity of Red LEDs in Section 2.
12	Green Section 2	000-255	Intensity of Green LEDs in Section 2.
13	Blue Section 2	000-255	Intensity of Blue LEDs in Section 2.
14	White Section 1	000-255	Intensity of White LEDs in Sections 1 through 6.



FALCON FX400
 360 X 1W CW / 384 X 0.5W RGB
 NR: 450120
 LED STROBE BAR

15	White Section 2	000-255	Intensity of White LEDs in Sections 7 through 12.
16	Red Section 3	000-255	Intensity of Red LEDs in Section 3.
17	Green Section 3	000-255	Intensity of Green LEDs in Section 3.
18	Blue Section 3	000-255	Intensity of Blue LEDs in Section 3.
19	Red Section 4	000-255	Intensity of Red LEDs in Section 4.
20	Green Section 4	000-255	Intensity of Green LEDs in Section 4.
21	Blue Section 4	000-255	Intensity of Blue LEDs in Section 4.
22	Auto Programs	000-255	Selects built-in automatic programs (e.g., Programs 1-15, specific ranges apply).
23	Auto Speed	000-255	Controls the speed of the selected Auto Program.
24	Device Settings	000-255	Control channel (See device settings)

38CH Mode

38CH Mode	Function	DMX Value	Description
1	Master Dimmer	000-255	Overall light output intensity (0-100%).
2	(White)Strobe Dimmer	000-255	Sets the overall intensity of the flash effect. Minimum -> Maximum
3	Beam/Strobe Strobe Duration(7-650ms)	000-255	Sets the length of time each flash is visible. 7-650ms
4	Beam/Strobe Strobe Rate(0.299 -> 16.67Hz)	000-255	Sets the frequency of flashes 0.299 -> 16.67Hz
5	No Function/Open	000-003	No Function
	Colour Macro 0-51	004-195	See colour macro list
	CTO	196-255	See CTO Macro list
6	Shutter	000-255	See shutter list
7	Frost Glass	000-001	No Function/Open



		002-255	Applies electronic frost effect 0-100%
8	Red Section 1	000-255	Intensity of Red LEDs in Section 1.
9	Green Section 1	000-255	Intensity of Green LEDs in Section 1.
10	Blue Section 1	000-255	Intensity of Blue LEDs in Section 1.
11	Red Section 2	000-255	Intensity of Red LEDs in Section 2.
12	Green Section 2	000-255	Intensity of Green LEDs in Section 2.
13	Blue Section 2	000-255	Intensity of Blue LEDs in Section 2.
14	Red Section 3	000-255	Intensity of Red LEDs in Section 3.
15	Green Section 3	000-255	Intensity of Green LEDs in Section 3.
16	Blue Section 3	000-255	Intensity of Blue LEDs in Section 3.
17	Red Section 4	000-255	Intensity of Red LEDs in Section 4.
18	Green Section 4	000-255	Intensity of Green LEDs in Section 4.
19	Blue Section 4	000-255	Intensity of Blue LEDs in Section 4.
20	White Section 1-3	000-255	Intensity of White LEDs in Sections 1-3.
21	White Section 4-6	000-255	Intensity of White LEDs in Sections 4-6.
22	White Section 7-9	000-255	Intensity of White LEDs in Sections 7-9.
23	White Section 10-12	000-255	Intensity of White LEDs in Sections 10-12.
24	Red Section 5	000-255	Intensity of Red LEDs in Section 5.
25	Green Section 5	000-255	Intensity of Green LEDs in Section 5.
26	Blue Section 5	000-255	Intensity of Blue LEDs in Section 5.
27	Red Section 6	000-255	Intensity of Red LEDs in Section 6.



FALCON FX400
 360 X 1W CW / 384 X 0.5W RGB
 NR: 450120
 LED STROBE BAR

28	Green Section 6	000-255	Intensity of Green LEDs in Section 6.
29	Blue Section 6	000-255	Intensity of Blue LEDs in Section 6.
30	Red Section 7	000-255	Intensity of Red LEDs in Section 7.
31	Green Section 7	000-255	Intensity of Green LEDs in Section 7.
32	Blue Section 7	000-255	Intensity of Blue LEDs in Section 7.
33	Red Section 8	000-255	Intensity of Red LEDs in Section 8.
34	Green Section 8	000-255	Intensity of Green LEDs in Section 8.
35	Blue Section 8	000-255	Intensity of Blue LEDs in Section 8.
36	Auto Programs	000-255	Selects built-in automatic programs (e.g., Programs 1-31, specific ranges apply).
37	Auto Speed	000-255	Controls the speed of the selected Auto Program.
38	Device Settings	000-255	Control channel (See device settings)

52CH Mode

52CH Mode	Function	DMX Value	Description
1	Master Dimmer	000-255	Overall light output intensity (0-100%).
2	(White)Strobe Dimmer	000-255	Sets the overall intensity of the flash effect. Minimum -> Maximum
3	Strobe Duration(7-650ms)	000-255	Sets the length of time each flash is visible. 7-650ms
4	Strobe Rate(0.299 -> 16.67Hz)	000-255	Sets the frequency of flashes 0.299 -> 16.67Hz
5	No Function/Open	000-003	
	Colour Macro 0-51	004-195	See colour macro list
	CTO	196-255	See CTO Macro list
6	Shutter	000-255	See shutter list
	Frost Glass	000-001	No Function/Open



FALCON FX400
360 X 1W CW / 384 X 0.5W RGB
NR: 450120
LED STROBE BAR

7		002-255	Applies electronic frost effect 0-100%
8	Red Section 1	000-255	Intensity of Red LEDs in Section 1.
9	Green Section 1	000-255	Intensity of Green LEDs in Section 1.
10	Blue Section 1	000-255	Intensity of Blue LEDs in Section 1.
11	Red Section 2	000-255	Intensity of Red LEDs in Section 2.
12	Green Section 2	000-255	Intensity of Green LEDs in Section 2.
13	Blue Section 2	000-255	Intensity of Blue LEDs in Section 2.
14	Red Section 3	000-255	Intensity of Red LEDs in Section 3.
15	Green Section 3	000-255	Intensity of Green LEDs in Section 3.
16	Blue Section 3	000-255	Intensity of Blue LEDs in Section 3.
17	Red Section 4	000-255	Intensity of Red LEDs in Section 4.
18	Green Section 4	000-255	Intensity of Green LEDs in Section 4.
19	Blue Section 4	000-255	Intensity of Blue LEDs in Section 4.
20	Red Section 5	000-255	Intensity of Red LEDs in Section 5.
21	Green Section 5	000-255	Intensity of Green LEDs in Section 5.
22	Blue Section 5	000-255	Intensity of Blue LEDs in Section 5.
23	Red Section 6	000-255	Intensity of Red LEDs in Section 6.
24	Green Section 6	000-255	Intensity of Green LEDs in Section 6.
25	Blue Section 6	000-255	Intensity of Blue LEDs in Section 6.
26	Red Section 7	000-255	Intensity of Red LEDs in Section 7.
27	Green Section 7	000-255	Intensity of Green LEDs in Section 7.



FALCON FX400
360 X 1W CW / 384 X 0.5W RGB
NR: 450120
LED STROBE BAR

28	Blue Section 7	000-255	Intensity of Blue LEDs in Section 7.
29	Red Section 8	000-255	Intensity of Red LEDs in Section 8.
30	Green Section 8	000-255	Intensity of Green LEDs in Section 8.
31	Blue Section 8	000-255	Intensity of Blue LEDs in Section 8.
32	Red Section 9	000-255	Intensity of Red LEDs in Section 9.
33	Green Section 9	000-255	Intensity of Green LEDs in Section 9.
34	Blue Section 9	000-255	Intensity of Blue LEDs in Section 9.
35	Red Section 10	000-255	Intensity of Red LEDs in Section 10.
36	Green Section 10	000-255	Intensity of Green LEDs in Section 10.
37	Blue Section 10	000-255	Intensity of Blue LEDs in Section 10.
38	Red Section 11	000-255	Intensity of Red LEDs in Section 11.
39	Green Section 11	000-255	Intensity of Green LEDs in Section 11.
40	Blue Section 11	000-255	Intensity of Blue LEDs in Section 11.
41	Red Section 12	000-255	Intensity of Red LEDs in Section 12.
42	Green Section 12	000-255	Intensity of Green LEDs in Section 12.
43	Blue Section 12	000-255	Intensity of Blue LEDs in Section 12.
44	White Section 1	000-255	Intensity of White LEDs in Section 1.
45	White Section 2	000-255	Intensity of White LEDs in Section 2.
46	White Section 3	000-255	Intensity of White LEDs in Section 3.
47	White Section 4	000-255	Intensity of White LEDs in Section 4.
48	White Section 5	000-255	Intensity of White LEDs in Section 5.



FALCON FX400
360 X 1W CW / 384 X 0.5W RGB
NR: 450120
LED STROBE BAR

49	White Section 6	000-255	Intensity of White LEDs in Section 6.
50	Auto Programs	000-255	Selects built-in automatic programs (e.g., Programs 1-31, specific ranges apply).
51	Auto Speed	000-255	Controls the speed of the selected Auto Program.
52	Device Settings	000-255	Control channel (See device settings)



FALCON FX400
 360 X 1W CW / 384 X 0.5W RGB
 NR: 450120
 LED STROBE BAR

94CH Mode

94CH Mode	Function	DMX Value	Description
1	Master Dimmer	000-255	Overall light output intensity (0-100%).
2	Strobe Dimmer	000-255	Sets the overall intensity of the flash effect.(only strobe section) Minimum -> Maximum
3	Strobe Duration(7-650ms)	000-255	Sets the length of time each flash is visible. 7-650ms (only strobe section)
4	Strobe Rate (0.299 -> 16.67Hz)	000-255	Sets the frequency of flashes 0.299 -> 16.67Hz (only strobe section)
5	No Function/Open	000-003	
	Colour Macro	004-195	See colour macro list
	CTO	196-255	See CTO Macro list
6	Shutter	000-255	See shutter list
7	Frost Glass	000-001	No Function/Open
		002-255	Applies electronic frost effect 0-100%
8	Red Section 1	000-255	Intensity of Red LEDs in Section 1.
9	Green Section 1	000-255	Intensity of Green LEDs in Section 1.
10	Blue Section 1	000-255	Intensity of Blue LEDs in Section 1.
11	Red Section 2	000-255	Intensity of Red LEDs in Section 2.
12	Green Section 2	000-255	Intensity of Green LEDs in Section 2.
13	Blue Section 2	000-255	Intensity of Blue LEDs in Section 2.
14	Red Section 3	000-255	Intensity of Red LEDs in Section 3.
15	Green Section 3	000-255	Intensity of Green LEDs in Section 3.
16	Blue Section 3	000-255	Intensity of Blue LEDs in Section 3.
17	Red Section 4	000-255	Intensity of Red LEDs in Section 4.



FALCON FX400
360 X 1W CW / 384 X 0.5W RGB
NR: 450120
LED STROBE BAR

18	Green Section 4	000-255	Intensity of Green LEDs in Section 4.
19	Blue Section 4	000-255	Intensity of Blue LEDs in Section 4.
20	Red Section 5	000-255	Intensity of Red LEDs in Section 5.
21	Green Section 5	000-255	Intensity of Green LEDs in Section 5.
22	Blue Section 5	000-255	Intensity of Blue LEDs in Section 5.
23	Red Section 6	000-255	Intensity of Red LEDs in Section 6.
24	Green Section 6	000-255	Intensity of Green LEDs in Section 6.
25	Blue Section 6	000-255	Intensity of Blue LEDs in Section 6.
26	Red Section 7	000-255	Intensity of Red LEDs in Section 7.
27	Green Section 7	000-255	Intensity of Green LEDs in Section 7.
28	Blue Section 7	000-255	Intensity of Blue LEDs in Section 7.
29	Red Section 8	000-255	Intensity of Red LEDs in Section 8.
30	Green Section 8	000-255	Intensity of Green LEDs in Section 8.
31	Blue Section 8	000-255	Intensity of Blue LEDs in Section 8.
32	Red Section 9	000-255	Intensity of Red LEDs in Section 9.
33	Green Section 9	000-255	Intensity of Green LEDs in Section 9.
34	Blue Section 9	000-255	Intensity of Blue LEDs in Section 9.
35	Red Section 10	000-255	Intensity of Red LEDs in Section 10.
36	Green Section 10	000-255	Intensity of Green LEDs in Section 10.
37	Blue Section 10	000-255	Intensity of Blue LEDs in Section 10.
38	Red Section 11	000-255	Intensity of Red LEDs in Section 11.



FALCON FX400
360 X 1W CW / 384 X 0.5W RGB
NR: 450120
LED STROBE BAR

39	Green Section 11	000-255	Intensity of Green LEDs in Section 11.
40	Blue Section 11	000-255	Intensity of Blue LEDs in Section 11.
41	Red Section 12	000-255	Intensity of Red LEDs in Section 12.
42	Green Section 12	000-255	Intensity of Green LEDs in Section 12.
43	Blue Section 12	000-255	Intensity of Blue LEDs in Section 12.
44	Red Section 13	000-255	Intensity of Red LEDs in Section 13.
45	Green Section 13	000-255	Intensity of Green LEDs in Section 13.
46	Blue Section 13	000-255	Intensity of Blue LEDs in Section 13.
47	Red Section 14	000-255	Intensity of Red LEDs in Section 14.
48	Green Section 14	000-255	Intensity of Green LEDs in Section 14.
49	Blue Section 14	000-255	Intensity of Blue LEDs in Section 14.
50	Red Section 15	000-255	Intensity of Red LEDs in Section 15.
51	Green Section 15	000-255	Intensity of Green LEDs in Section 15.
52	Blue Section 15	000-255	Intensity of Blue LEDs in Section 15.
53	Red Section 16	000-255	Intensity of Red LEDs in Section 16.
54	Green Section 16	000-255	Intensity of Green LEDs in Section 16.
55	Blue Section 16	000-255	Intensity of Blue LEDs in Section 16.
56	Red Section 17	000-255	Intensity of Red LEDs in Section 17.
57	Green Section 17	000-255	Intensity of Green LEDs in Section 17.
58	Blue Section 17	000-255	Intensity of Blue LEDs in Section 17.
59	Red Section 18	000-255	Intensity of Red LEDs in Section 18.



FALCON FX400
360 X 1W CW / 384 X 0.5W RGB
NR: 450120
LED STROBE BAR

60	Green Section 18	000-255	Intensity of Green LEDs in Section 18.
61	Blue Section 18	000-255	Intensity of Blue LEDs in Section 18.
62	Red Section 19	000-255	Intensity of Red LEDs in Section 19.
63	Green Section 19	000-255	Intensity of Green LEDs in Section 19.
64	Blue Section 19	000-255	Intensity of Blue LEDs in Section 19.
65	Red Section 20	000-255	Intensity of Red LEDs in Section 20.
66	Green Section 20	000-255	Intensity of Green LEDs in Section 20.
67	Blue Section 20	000-255	Intensity of Blue LEDs in Section 20.
68	Red Section 21	000-255	Intensity of Red LEDs in Section 21.
69	Green Section 21	000-255	Intensity of Green LEDs in Section 21.
70	Blue Section 21	000-255	Intensity of Blue LEDs in Section 21.
71	Red Section 22	000-255	Intensity of Red LEDs in Section 22.
72	Green Section 22	000-255	Intensity of Green LEDs in Section 22.
73	Blue Section 22	000-255	Intensity of Blue LEDs in Section 22.
74	Red Section 23	000-255	Intensity of Red LEDs in Section 23.
75	Green Section 23	000-255	Intensity of Green LEDs in Section 23.
76	Blue Section 23	000-255	Intensity of Blue LEDs in Section 23.
77	Red Section 24	000-255	Intensity of Red LEDs in Section 24.
78	Green Section 24	000-255	Intensity of Green LEDs in Section 24.
79	Blue Section 24	000-255	Intensity of Blue LEDs in Section 24.
80	White Section 1	000-255	Intensity of White LEDs in Section 1.



FALCON FX400
360 X 1W CW / 384 X 0.5W RGB
NR: 450120
LED STROBE BAR

81	White Section 2	000-255	Intensity of White LEDs in Section 2.
82	White Section 3	000-255	Intensity of White LEDs in Section 3.
83	White Section 4	000-255	Intensity of White LEDs in Section 4.
84	White Section 5	000-255	Intensity of White LEDs in Section 5.
85	White Section 6	000-255	Intensity of White LEDs in Section 6.
86	White Section 7	000-255	Intensity of White LEDs in Section 7.
87	White Section 8	000-255	Intensity of White LEDs in Section 8.
88	White Section 9	000-255	Intensity of White LEDs in Section 9.
89	White Section 10	000-255	Intensity of White LEDs in Section 10.
90	White Section 11	000-255	Intensity of White LEDs in Section 11.
91	White Section 12	000-255	Intensity of White LEDs in Section 12.
92	Auto Programs	000-255	Selects built-in automatic programs (e.g., Programs 1-31, specific ranges apply).
93	Auto Speed	000-255	Controls the speed of the selected Auto Program.
94	Device Settings	000-255	Control channel (See device settings)



FALCON FX400
360 X 1W CW / 384 X 0.5W RGB
NR: 450120
LED STROBE BAR

AUTO LIST

Macro Number	Description	DMX Value
0	No Function/OPEN	0-7
1	auto 1	8 - 15
2	auto 2	16-23
3	auto 3	24-31
4	auto 4	32-39
5	auto 5	40-47
6	auto 6	48-55
7	auto 7	56-63
8	auto 8	64-71
9	auto 9	72-79
10	auto 10	80-87
11	auto 11	88-95
12	auto 12	96-103
13	auto 13	104-111
14	auto 14	112-119
15	auto 15	120-127
16	auto 16	128-135
17	auto 17	136-143
18	auto 18	144-151
19	auto 19	152-159
20	auto 20	160-167
21	auto 21	168-175
22	auto 22	176-183
23	auto 23	184-191
24	auto 24	192-199
25	auto 25	200-207
26	auto 26	208-215
27	auto 27	216-223
28	auto 28	224-231
29	auto 29	232-239
30	auto 30	240-247
31	auto 31	248-255



FALCON FX400
 360 X 1W CW / 384 X 0.5W RGB
 NR: 450120
 LED STROBE BAR

Shutter List

Shutter Functions	DMX Value	Description
No Function/OPEN	000-004	Open/No Function
Strobe All 1-20Hz	005-049	Strobe Slow -> Fast (Whole fixture strobe)
Burst Strobe 1-20Hz	050-099	Burst Strobe 1-20Hz
Random Strobe	100-149	Random Strobe All
Random Burst Strobe	150-199	Random Strobe
Random Single Pixel Strobe	200-224	Random Strobe on single pixels
Random Single Pixel Burst Strobe	225-255	Random Burst Strobe on Pixels

Device Settings (Hold 3s)

Control Functions	DMX Value
No function/Open	0-44
Pixel orientation Pixel on	45-49
Pixel orientation Pixel off	50-54
Dimmer curve Linear	55-59
Dimmer curve Square Law	60-64
Dimmer curve Inverse Square Law	65-69
Dimmer curve S-Curve	70-74
No function/Open	75-89
Calibrated colour output mode - COLOR CALIB = On	90-94
Raw colour output mode - COLOR CALIB = OFF	95-99
No function/Open	100-149
Record User Color 1	150-154
Record User Color 2	155-159
Record User Color 3	160-164
Record User Color 4	165-169
Record User Color 5	170-174
Record User Color 6	175-179
Record User Color 7	180-184
Record User Color 8	185-189
No function/Open	190-249
Illuminate display	250-255



FALCON FX400
 360 X 1W CW / 384 X 0.5W RGB
 NR: 450120
 LED STROBE BAR

Color Macro List

Macro Number	Functions	DMX Value	RED	GREEN	BLUE	
0	No Function/OPEN	0-3				
1	Burgundy	4-5	128	0	32	
2	Crimson	6-7	220	20	60	
3	Deep Red	8-9	200	0	0	
4	Lava Red	10-11	255	40	0	
5	Maroon	12-13	128	0	0	
6	Medium Red	14-15	220	0	0	
7	Neon Red	16-17	255	50	0	
8	Red	18-19	255	0	0	
9	Rose Pink	20-21	255	102	178	
10	Rose Red	22-23	255	51	52	
11	Amber	24-25	255	127	13	
12	Apricot	26-27	255	158	74	
13	Bastard Amber	28-29	255	151	51	
14	Burnt Orange	30-31	255	70	0	
15	Golden Amber	32-33	255	186	40	
16	Light Amber	34-35	255	206	100	
17	Neon Orange	36-37	255	80	0	
18	Orange	38-39	255	90	0	
19	Sunset Orange	40-41	255	110	20	
20	Champagne	42-43	255	232	97	
21	Gold	44-45	255	203	13	
22	Ivory	46-47	225	255	78	
23	Neon Yellow	48-49	230	255	0	
24	Pale Gold	50-51	255	221	65	
25	Peach	52-53	255	195	111	
26	Straw Yellow	54-55	255	241	51	
27	Yellow	56-57	255	220	0	
28	Chartreuse	58-59	120	255	0	
29	Emerald Green	60-61	0	200	85	
30	Forest Green	62-63	0	128	32	































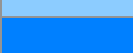

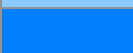
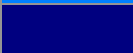
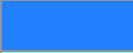
FALCON FX400

360 X 1W CW / 384 X 0.5W RGB

NR: 450120

LED STROBE BAR

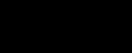
31	Green	64-65	0	255	0	
32	Light Green	66-67	39	255	39	
33	Lime	68-69	190	255	0	
34	Medium Green	70-71	0	200	0	
35	Mint Green	72-73	133	255	78	
36	Neon Green	74-75	0	255	80	
37	Sea Green	76-77	0	190	140	
38	Seafoam	78-79	146	255	255	
39	Tropical Green	80-81	52	153	95	
40	Aqua	82-83	0	204	204	
41	Cyan	84-85	0	255	255	
42	Dark Teal	86-87	0	128	128	
43	Neon Cyan	88-89	100	255	255	
44	Teal	90-91	0	128	128	
45	Turquoise	92-93	64	224	208	
46	Blue	94-95	0	0	255	
47	Cobalt Blue	96-97	0	180	255	
48	Congo Blue	98-99	47	0	112	
49	Crystal Blue	100-101	64	180	255	
50	Deep Blue	102-103	0	0	200	
51	Electric Blue	104-105	0	128	255	
52	Ice Blue	106-107	140	223	255	
53	Indigo	108-109	0	128	255	
54	Light Blue	110-111	138	204	255	
55	Medium Blue	112-113	0	128	255	
56	Navy Blue	114-115	0	0	128	
57	Neon Blue	116-117	32	128	255	
58	Sky Blue	118-119	135	255	235	
59	Dark Lavender	120-121	183	102	255	
60	Deep Purple	122-123	128	0	128	
61	Lavender	124-125	212	146	255	
62	Mauve	126-127	203	104	255	
63	Medium Lavender	128-129	203	134	255	



FALCON FX400
 360 X 1W CW / 384 X 0.5W RGB
 NR: 450120
 LED STROBE BAR

64	Neon Purple	130-131	200	100	255	
65	Plum	132-133	128	0	64	
66	Purple	134-135	96	0	160	
67	Blush Pink	136-137	255	167	185	
68	Flamingo Pink	138-139	255	102	148	
69	Fuchsia	140-141	255	0	160	
70	Hot Pink	142-143	255	32	128	
71	Light Pink	144-145	255	184	203	
72	Magenta	146-147	255	0	255	
73	Neon Pink	148-149	255	0	200	
74	Pink	150-151	255	102	148	
75	Cool White	152-153	226	234	255	
76	Lanthanated	154-155	255	247	89	
77	Neon White	156-157	128	128	128	
78	Open White	158-159	255	255	255	
79	Warm White	160-161	255	221	101	
80	Laser Lemon	162-163	154	255	40	
81	User Color 1	164-167				
82	User Color 2	168-171				
83	User Color 3	172-175				
84	User Color 4	176-179				
85	User Color 5	180-183				
86	User Color 6	184-187				
87	User Color 7	188-191				
88	User Color 8	192-195				

CTO Macro List

Macro Number	Functions	DMX Value
1	2700K	196-199
2	3200K	200-203
3	3500K	204-207
4	4000K	208-211
5	4500K	212-215



FALCON FX400
360 X 1W CW / 384 X 0.5W RGB
NR: 450120
LED STROBE BAR

6	5000K	216-219
7	5600K	220-223
8	6000K	224-227
9	6500K	228-231
10	7000K	232-235
11	7500K	236-239
12	8000K	240-255



FALCON FX400
360 X 1W CW / 384 X 0.5W RGB
NR: 450120
LED STROBE BAR

Company info

Mail: info@eaglelite.dk

TLF: +45 27 58 72 31

WEB: <https://eaglelite.eu/>

Company: Eagle Lite

CVR: DK39524627



UK CA CE