



QUAD19 WASH



19X15W RGBW WASH MOVING HEAD

QUAD19 WASH is a reliable and cost-effective moving head wash fixture designed for events, rental applications, and fixed installations where solid performance and flexibility are required. Equipped with 19 × 15W RGBW LEDs, it delivers an even and punchy wash output with smooth color mixing and good brightness for its class. The motorized zoom range of 8°–55° allows the fixture to cover both tighter wash looks and wider stage areas, making it a practical choice for a wide range of standard lighting setups. Smooth 16-bit pan and tilt movement ensures stable positioning and consistent movement during shows. Integrated RGB background LEDs add visual presence and simple effect possibilities without adding complexity. Control is handled via DMX512, with both 3-pin and 5-pin XLR connections, while TRUE1 IN/THRU provides safe and convenient power linking. Built in a robust housing with a dependable cooling system, the QUAD19 WASH offers a balanced combination of performance, features, and affordability for professional environments that demand reliability without high-end pricing.

- 19 × 15W RGBW LED
- Smooth and even wash output
- Motorized zoom range: 8°–55°
- 540° pan / 270° tilt movement
- 16-bit pan & tilt resolution
- Integrated RGB background LEDs
- Electronic dimming with smooth fades
- DMX512 & RDM Control
- Strobe and shutter effects
- Multiple DMX Channel Modes (14/25/25/33 ch)
- Smart Temperature control
- TRUE1 Power IN & OUT
- 3-pin & 5-pin XLR DMX connections
- Low noise fans Design
- Lightweight Housing

RGBW Color Mixing



LED 19x15W RGBW	 MOTORIZED ZOOM 8-55°
 IP20	 DMX/RDM
UK CA	CE





QUADIS WASH 19x15W RGBW WASH MOVING HEAD

SPECIFICATION SHEET

OPTICAL PARAMETERS

Main LED:	19 × 15W RGBW LEDs (4-in-1)
Background LEDs:	30 × 0.5W RGB LEDs
Source Life Expectancy:	50,000 Hours
Zoom:	Motorized 8°–55°
Beam Type:	Wash / zoom wash coverage
Optics:	Zoom lens system for tight-to-wide beam adjustment
Dimming:	16-bit 0–100% smooth, flicker-free dimming
Color Mixing:	Homogeneous RGBW color blending

DYNAMIC EFFECTS

Dimming:	0–100% smooth dimming (flicker-free)
Dimming Resolution:	16-bit Dimming
Built-in Programs:	Integrated dynamic show programs
Stand-Alone Mode:	Manual, Auto & Sound modes Adjustable
Background LED Effects:	Separate RGB background effects
Pixel/Section control:	Multiple pixel zones to control
Shutter/Strobe:	1 – 20 Hz
Thermal Protection:	Integrated temperature protection

PHYSICAL

Pan Range:	540°
Tilt Range:	270°
Movement Resolution:	16-bit pan & tilt
Ingress Protection Rating:	IP20, Indoor/dry
Cooling:	Lownoise Fans
Mounting Options:	Truss or floor mounting
Signal connection:	3 & 5-Pin XLR IN/THRU
Power connection:	Seetronic True1 IN/THRU
Mounting:	2x Omega Brackets
Housing:	Metal/Plastic
Color:	Black / White(optional)
Dimensions (WxHxD)mm:	312 x 364 x 222
Weight:	8,0kg

COLOR SYSTEM

Color Mixing:	RGBW Color mixing
Macros:	Color Macro & CTO Presets Selectable via DMX

ELECTRICAL

Input Voltage:	100–240V – 50/60Hz
Max Power Consumption:	285W / 1.23A @ 230V
Power factor:	>0.95
Fuse:	5 mm × 20 mm, 4 A, 250 V, fastacting
Standby Power consumption:	10.0W
Thermal Protection:	Integrated temperature protection
Operating Temperature:	-10°C to +50°C

CONTROL

Protocols:	DMX512 & RDM
DMX channels:	14 / 25 / 25 / 33 ch
User Interface:	LCD display with menu buttons
LED Color Calibration:	Yes
Standalone Operation:	Built in Auto, Sound modes & Manual

OPTIONAL ACCESSORIES:

4in1/6in1 FlightCase made in EU	Power Linking Cables
4in1/6in1 FlightCase made in P.R.C.	Selflock Couplers
Omega Bracket	Omega Bracket





QUADIS WASH 19x15W RGBW WASH MOVING HEAD

SIZE

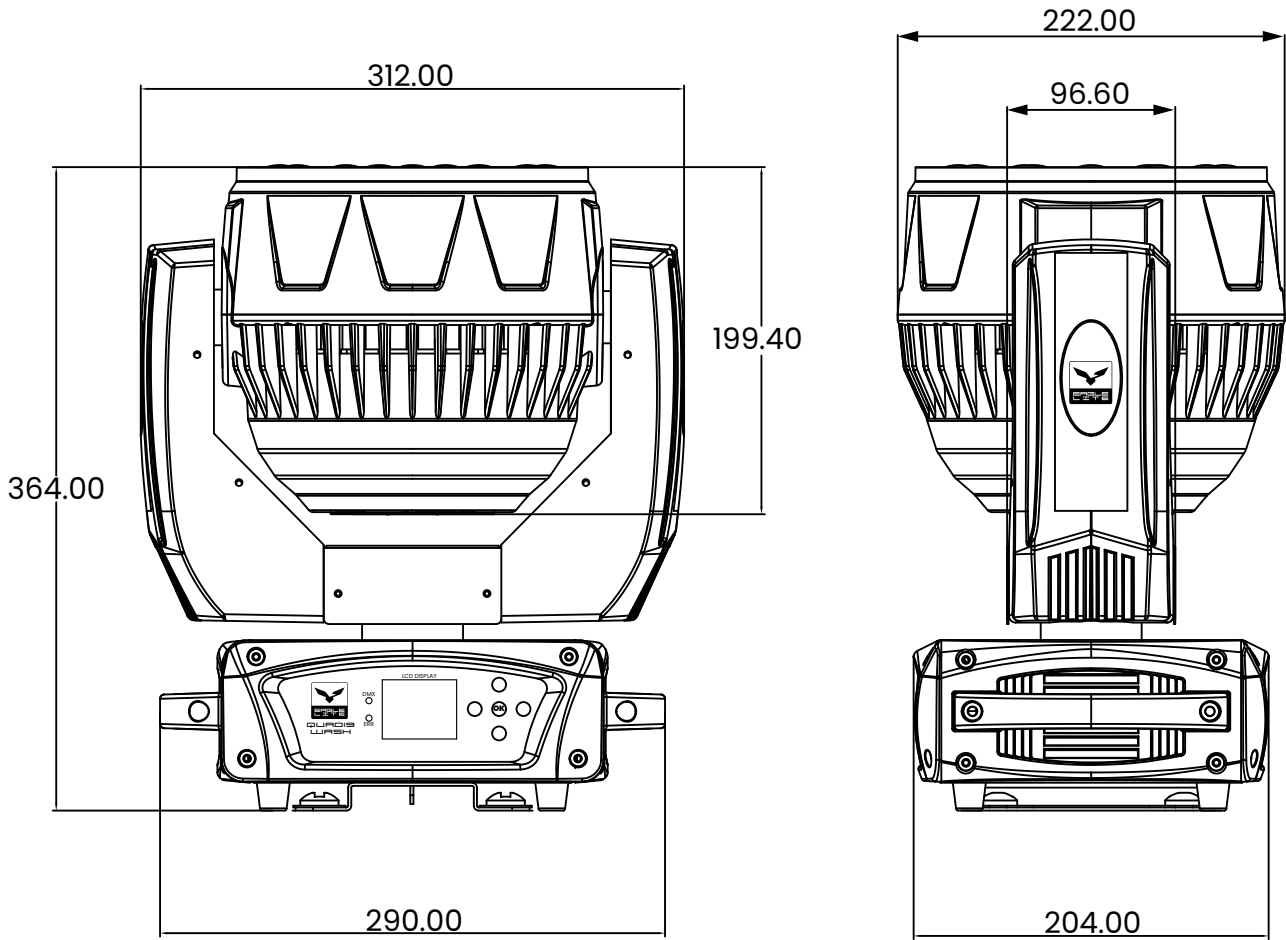

PRODUCT PICTURES



QUADIS WASH 19x15W RGBW WASH MOVING HEAD

PIXEL ZONES

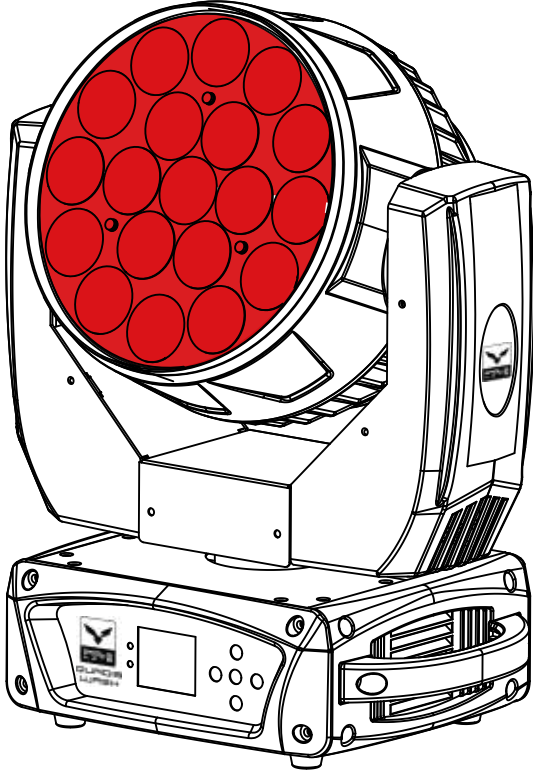

SIMPLE 14 CH

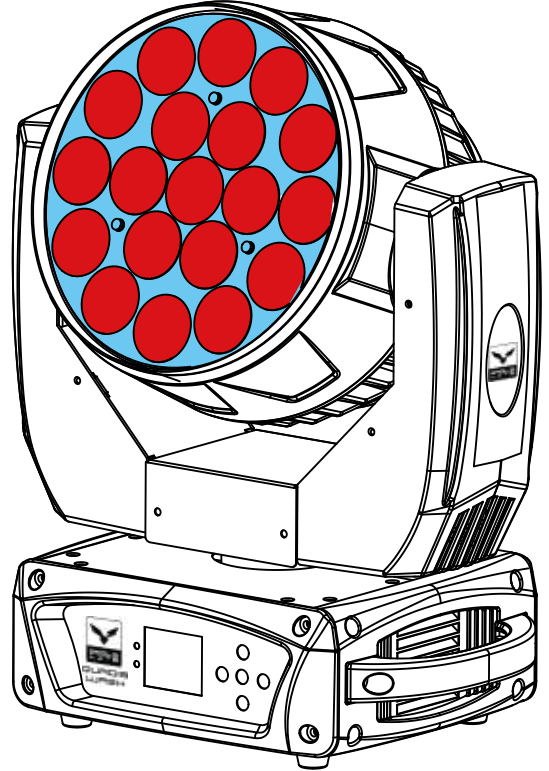

EXTEND 25.A CH

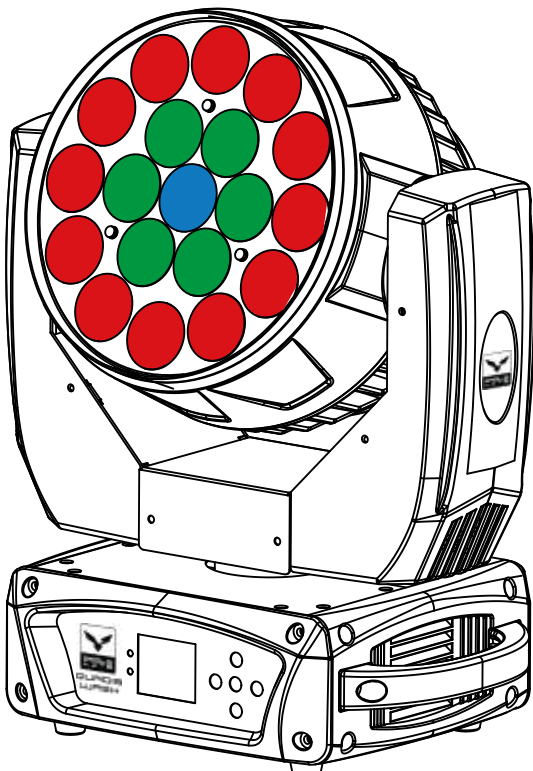

EXTEND 25.B CH

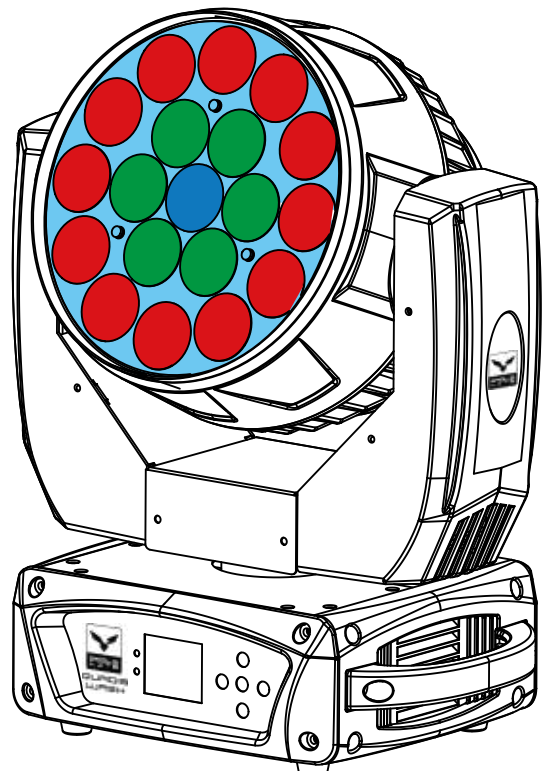

FULL 33 CH